

**Demontage • Disassembly • Démontage • Smontaggio**

Falzmontage  
Top fixing  
Montage en feuillure  
Montaggio a libro

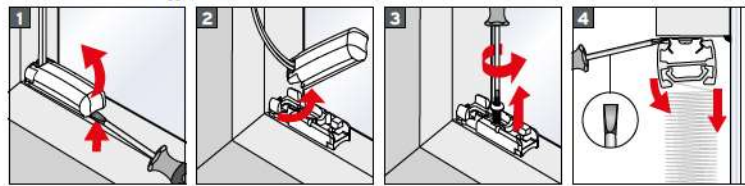

Winkelmontage  
Face fixing  
Montage en angle  
Montaggio ad angolo

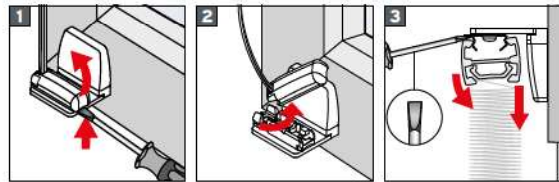

**Option • Opzione**

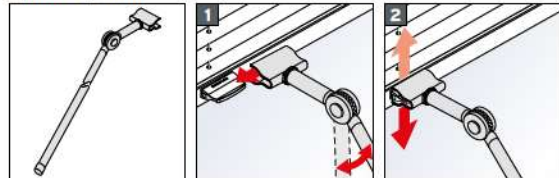

**Montageanleitung • Assembly instruction  
Instructions de montage • Istruzioni di montaggio**

DE • EN • FR • IT

**VS 1, VS 3, VS 3 SD**

Wichtig! Bitte mit den Produkthinweisen aufbewahren! • Important! Please keep together with product information!  
Important! A conserver avec les instructions relatives au produit! • Importante! Si prega di attenersi alle istruzioni del prodotto!

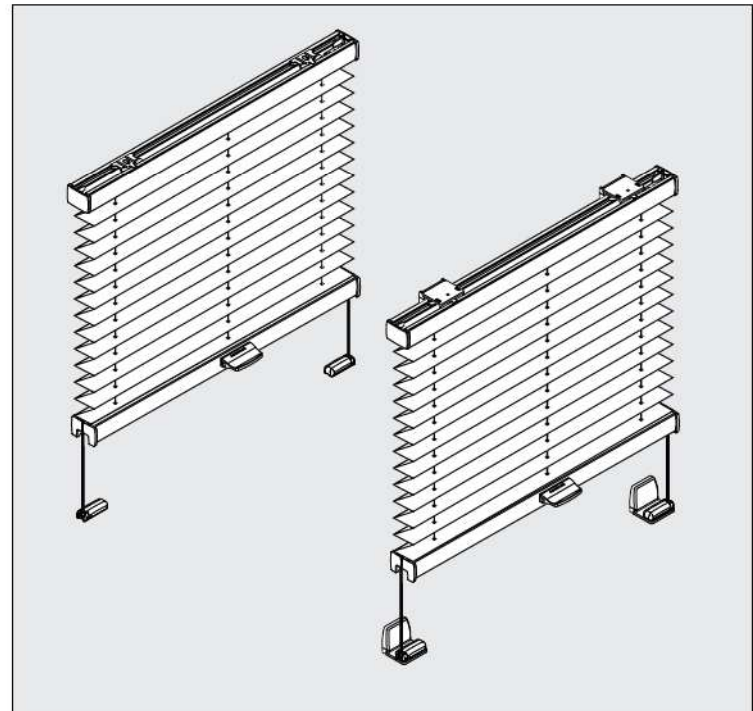
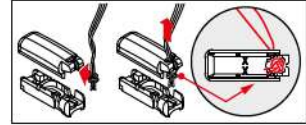
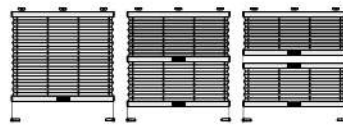

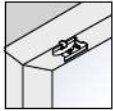

**Falzmontage**  
**Top fixing**  
**Montage en feuillure**  
**Montaggio a libro**

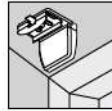
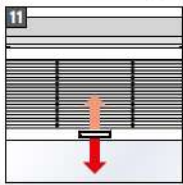
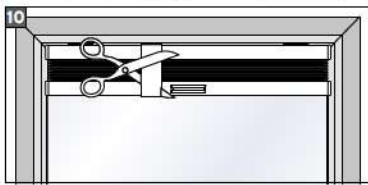
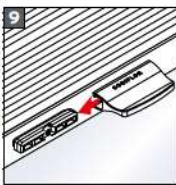
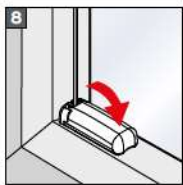
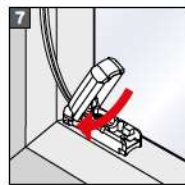
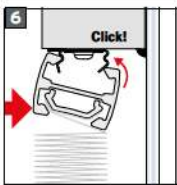
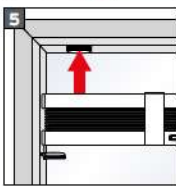
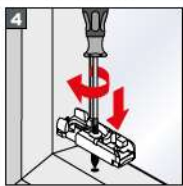
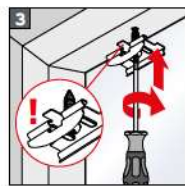
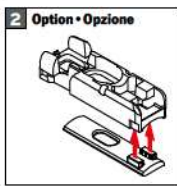
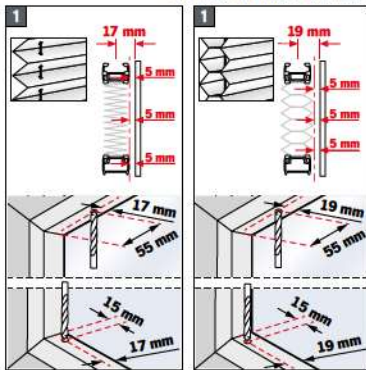
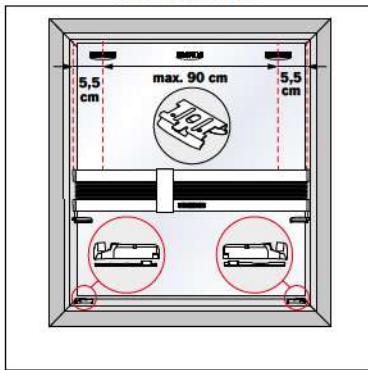
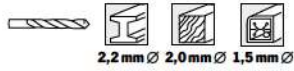

**Winkelmontage**  
**Face fixing**  
**Montage en angle**  
**Montaggio ad angolo**

